

PMT Panel Mount Power Supply

5V 50W 1 Phase / PMT-5V50W1A□

PMT



Highlights & Features

- Universal AC input range
- Power will not de-rate from input voltage 100Vac to 264Vac
- High MTBF > 700,000 hrs. per Telcordia SR-332
- Short Circuit / Overvoltage / Overload / Over Temperature Protections
- Versatile connector options (Terminal Block, Front Face)

Safety Standards



CB Certified for worldwide use

Model Number: PMT-5V50W1A□
Unit Weight: 0.23 kg
Dimensions (L x W x D): 98 x 98 x 38 mm

General Description

The new PMT series of panel mount power supplies is the latest offering from one of the world's largest power supply manufacturers and solution providers – Delta. The PMT products also offer a nominal output voltage of 5V with a wide operating temperature range from -10°C to +70°C and can withstand shock and vibration requirements (in accordance to IEC 60068-2-27 and IEC 60068-2-6 respectively). In addition to features like overvoltage and overload protections, Delta's PMT series of panel mount power supplies is unlike many other brands in the same price level. The PMT series is designed for cost competitive markets without compromising the quality of the components and product specifications. The series of products has an expected life time of 10 years and this versatile product has three different connector options (Terminal Block and Front Face) and can also be converted into L Frame (PML) type of power supplies to satisfy different application needs.

Model Information

PMT Panel Mount Power Supply

Model Number	Input Voltage Range	Output Voltage	Output Current
PMT-5V50W1A□	85-264Vac	5Vdc	10.0A

Model Numbering

							CC Code**
PM	□ –	5V	50W	1	A	□	□
Panel Mount	Product Type T – Enclosed L – L Frame*	Output Voltage	Output Power	Single Phase	No PFC	Connector Type A – Terminal Block G – Front Face*	Blank – Without connector cover A – With connector cover

*Options

**For Terminal Block

PMT Panel Mount Power Supply

5V 50W 1 Phase / PMT-5V50W1A□

Specifications

Input Ratings / Characteristics

Nominal Input Voltage	100-240Vac
Input Voltage Range	85-264Vac
Nominal Input Frequency	50-60Hz
Input Frequency Range	47-63Hz
Input Current	< 1.10A @ 115Vac, < 0.65A @ 230Vac
Efficiency at 100% Load	82.0% typ. @ 230Vac
Max Inrush Current (Cold Start)	45A typ. @ 230Vac
Leakage Current	< 1mA @ 240Vac

Output Ratings / Characteristics

Nominal Output Voltage	5Vdc
Output Voltage Tolerance	± 1% (initial set point tolerance from factory)
Output Voltage Adjustment Range	4.50-5.50Vdc
Output Current	10.0A
Output Power	50W
Line Regulation	< 0.5% typ. (@ 115Vac & 230Vac input, 100% input)
Load Regulation	< 1% typ. (@ 115Vac & 230Vac input, 0-100% input)
PARD (20MHz)	< 80mVpp @ 25°C to 50°C, < 160mVpp @ -10°C to 0°C
Rise Time	< 30ms @ nominal input (100% load)
Start-up Time	1,200ms typ. @ 115Vac, 500ms typ. @ 230Vac (100% load)
Hold-up Time	20ms typ. @ 115Vac, 100ms typ. @ 230Vac
Dynamic Response (Overshoot & Undershoot O/P Voltage)	± 10% (1000mV _{p-p}) @ 0-100% load (Slew Rate: 0.1A/μS)
Start-up with Capacitive Loads	8,000μF Max

Mechanical

Case Chassis	Aluminium	
Case Cover	SGCC	
Dimensions (L x W x D)	98 x 98 x 38 mm	
Unit Weight	0.23 kg	
Indicator	Green LED (DC OK)	
Cooling System	Convection	
Terminal	PM□-5V50W1A□	M3.5 x 5 Pins (Rated 300V/15A)
	PM□-5V50W1A□	M3.5 x 5 Pins (Rated 300V/20A)
Wire	PM□-5V50W1A□	AWG 14-12
	PM□-5V50W1A□	AWG 14-12
Noise (1 Meter from power supply)	Sound Pressure Level (SPL) < 25dBA	

PMT Panel Mount Power Supply

5V 50W 1 Phase / PMT-5V50W1A□

Environment

Surrounding Air Temperature	Operating	-10°C to +70°C
	Storage	-25°C to +85°C
Power De-rating	> 50°C de-rate power by 2.5% / °C < 100Vac de-rate power by 1.33% / V (80% load @ 85Vac)	
Operating Humidity	5 to 95% RH (Non-Condensing)	
Operating Altitude	0 to 5,000 Meters	
Shock Test (Non-Operating)	IEC 60068-2-27, Half Sine Wave: 50G for a duration of 11ms, 3 shocks for each 3 directions	
Vibration (Non-Operating)	IEC 60068-2-6, Random: 5Hz to 500Hz (2.09Grms); 20 min per axis for all X, Y, Z direction	
Pollution Degree	2	

Protections

Overvoltage	5.75-7.50V, SELV Output, Hiccup Mode, Non-Latching (Auto-Recovery)
Overload / Overcurrent	105-150% of rated load current, Hiccup Mode, Non-Latching (Auto-Recovery)
Over Temperature	Non-Latching (Auto-Recovery)
Short Circuit	Hiccup Mode, Non-Latching (Auto-Recovery when the fault is removed)
Protection Against Shock	Class I with PE* connection

*PE: Primary Earth

Reliability Data

MTBF	> 700,000 hrs. as per Telcordia SR-332 I/P: 100Vac, O/P: 100% Load, Ta: 35°C)
Expected Cap Life Time	10 years (115Vac & 230Vac, 50% load @ 40°C)

Safety Standards / Directives

Electrical Safety	TUV Bauart to EN60950-1, UL/cUL recognized to UL 60950-1 and CSA C22.2 No. 60950-1, CB scheme to IEC 60950-1, CCC to GB4943	
CE	In conformance with EMC Directive 2004/108/EC and Low Voltage Directive 2006/95/EC	
Material and Parts	RoHS Directive 2011/65/EU Compliant	
Galvanic Isolation	Input to Output	3.0KVac
	Input to Ground	1.5KVac
	Output to Ground	0.5KVac

PMT Panel Mount Power Supply

5V 50W 1 Phase / PMT-5V50W1A□

EMC

EMC / Emissions		CISPR 22, EN 55022, FCC Title 47: Class B
Immunity to		EN 55024
Electrostatic Discharge	IEC 61000-4-2	Level 4 Criteria A ¹⁾ Air Discharge: 15kV Contact Discharge: 8kV
Radiated Field	IEC 61000-4-3	Level 3 Criteria A ¹⁾ 80MHz-1GHz, 10V/M with 1kHz tone / 80% modulation
Electrical Fast Transient / Burst	IEC 61000-4-4	Level 3 Criteria A ¹⁾ 2kV
Surge	IEC 61000-4-5	Level 3 Criteria A ¹⁾ Common Mode ²⁾ : 2kV Differential Mode ³⁾ : 1kV
Conducted	IEC 61000-4-6	Level 3 Criteria A ¹⁾ 150kHz-80MHz, 10Vrms
Power Frequency Magnetic Fields	IEC 61000-4-8	Criteria A ¹⁾ 10A/Meter
Voltage Dips	IEC 61000-4-11	100% dip; 1 cycle (20ms); Self Recoverable
Low Energy Pulse Test (Ring Wave)	IEC 61000-4-12	Level 3 200A Criteria A ¹⁾ Common Mode ²⁾ : 2kV Differential Mode ³⁾ : 1kV

1) Criteria A: Normal performance within the specification limits
 2) Asymmetrical: Common mode (Line to earth)
 3) Symmetrical: Differential mode (Line to line)

Block Diagram

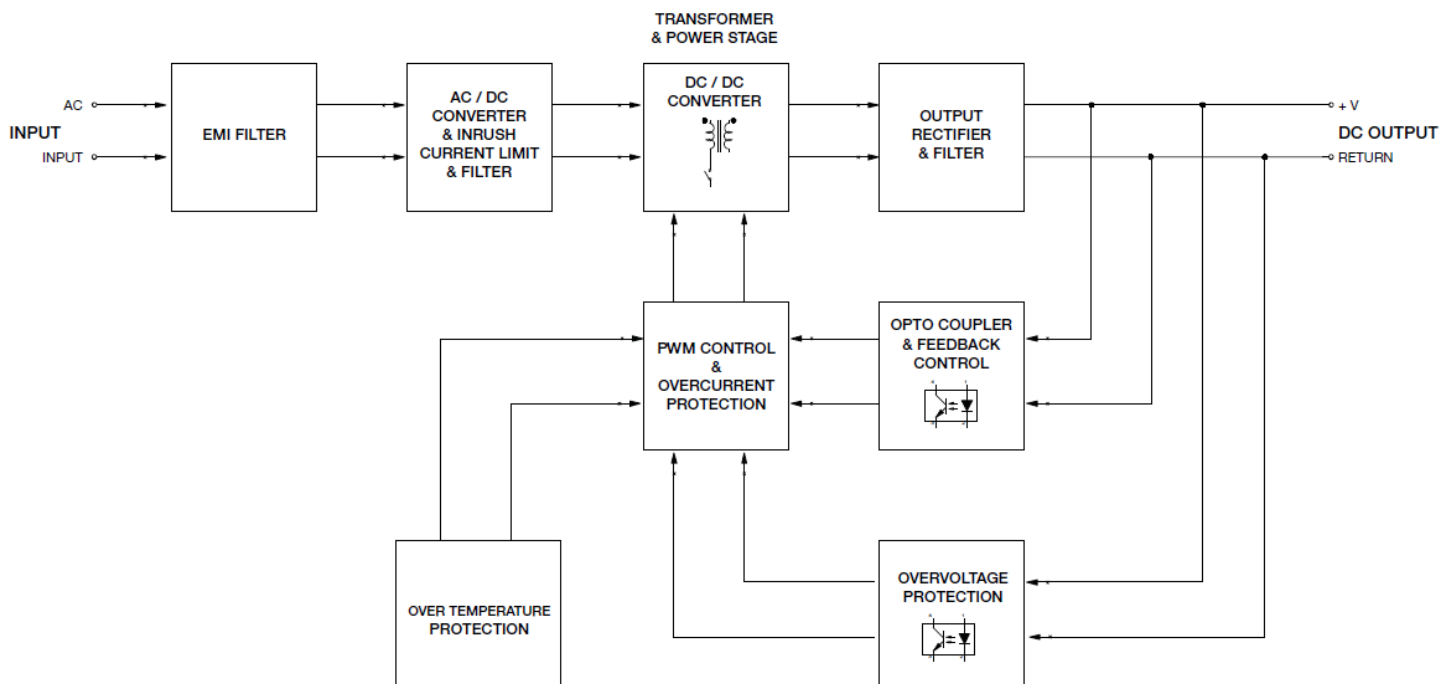

PMT Panel Mount Power Supply

5V 50W 1 Phase / PMT-5V50W1A□

Device Descriptions

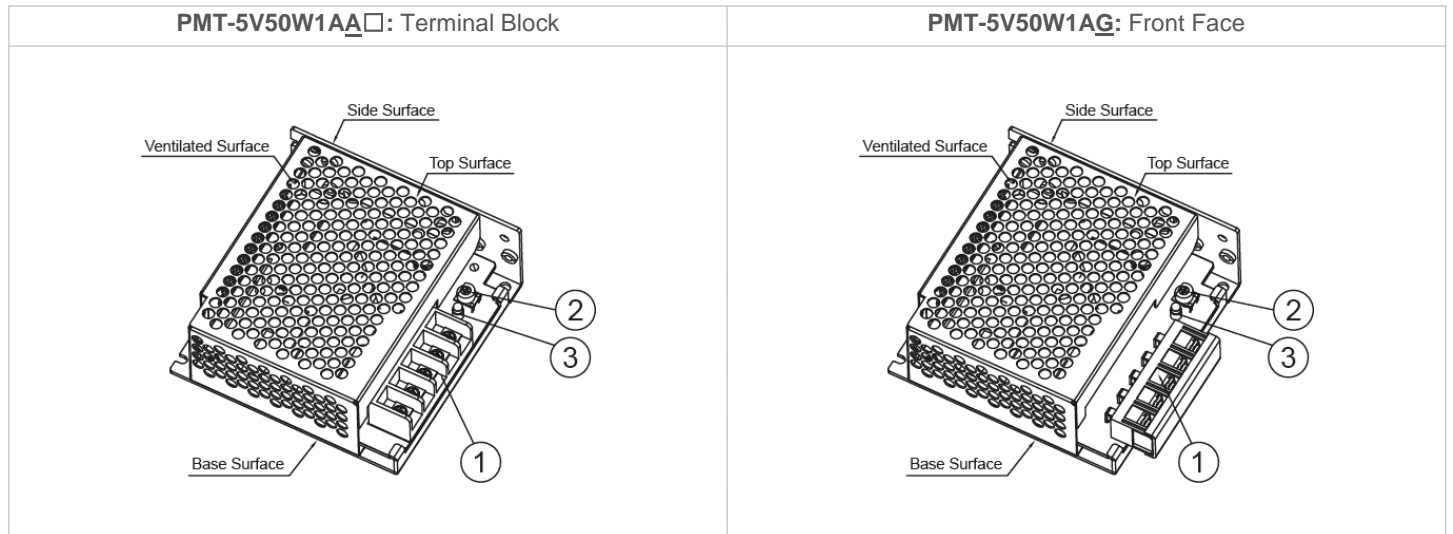

- 1) Input & Output terminal block connector
- 2) DC voltage adjustment potentiometer
- 3) DC OK control LED (Green)

Dimensions

L x W x D: 98 x 98 x 38 mm (PMT-5V50W1A□: Terminal Block)

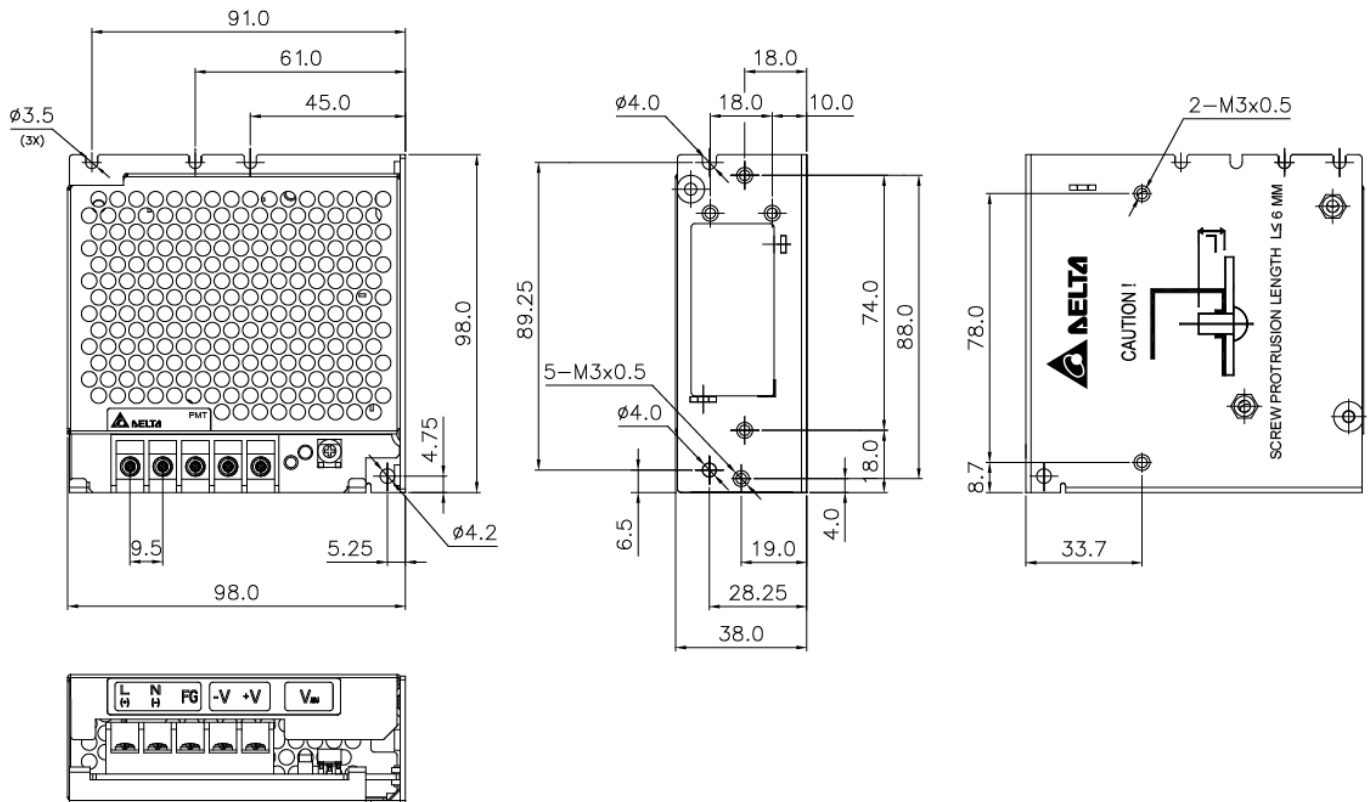

PMT Panel Mount Power Supply

5V 50W 1 Phase / PMT-5V50W1A□

L x W x D: 98 x 98 x 38 mm (PMT-5V50W1A□: Front Face)

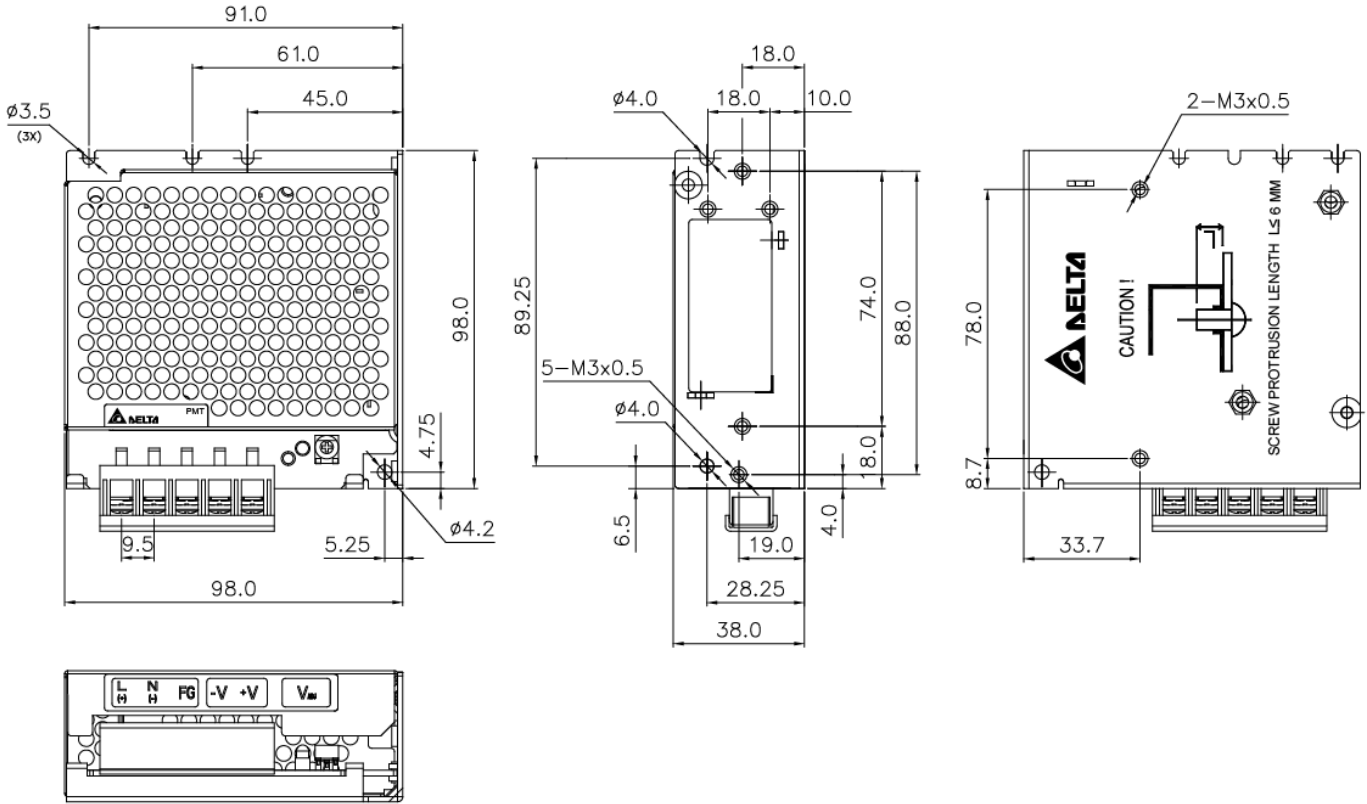

L x W x D: 98 x 98 x 37.5 mm (PML-5V50W1A□: Terminal Block)

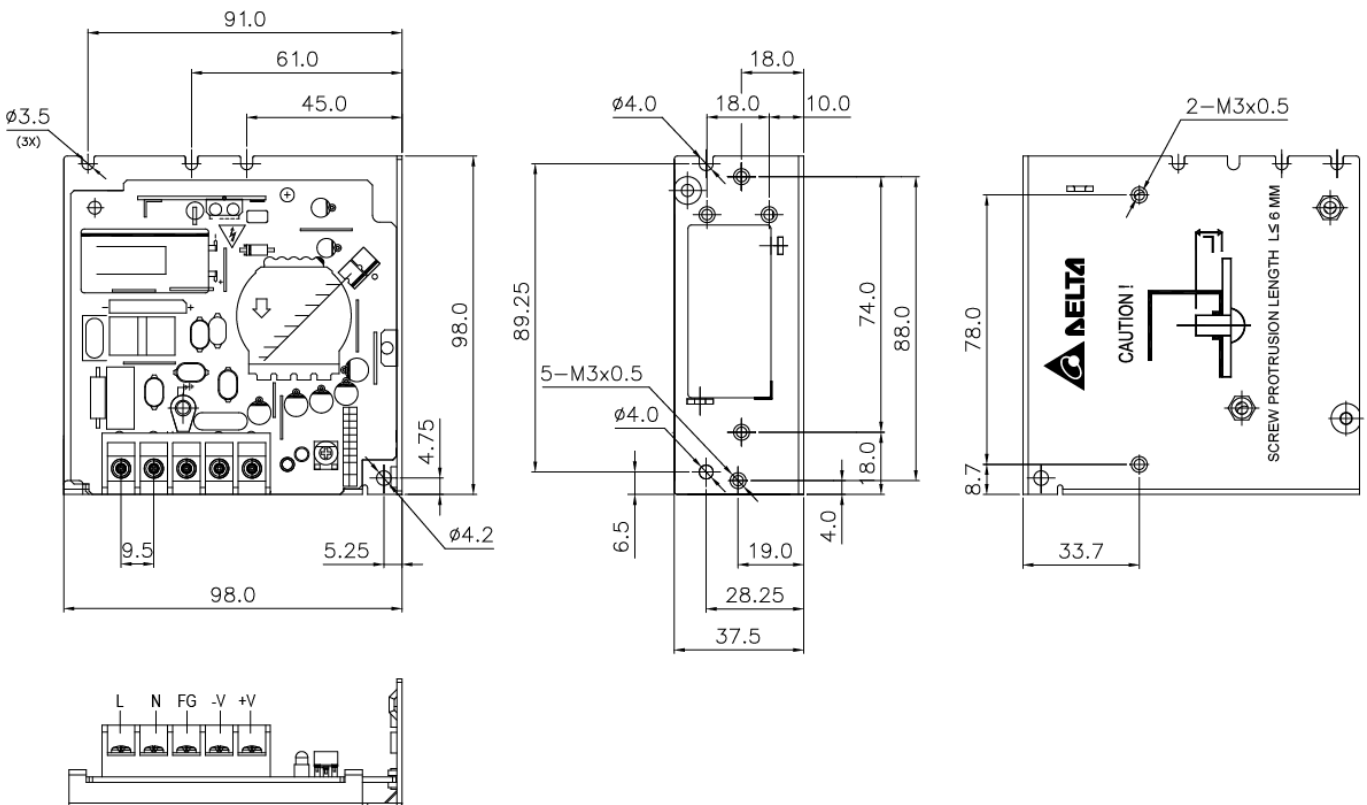

PMT Panel Mount Power Supply

5V 50W 1 Phase / PMT-5V50W1A□

L x W x D: 98 x 98 x 37.5 mm (PML-5V50W1AG: Front Face)

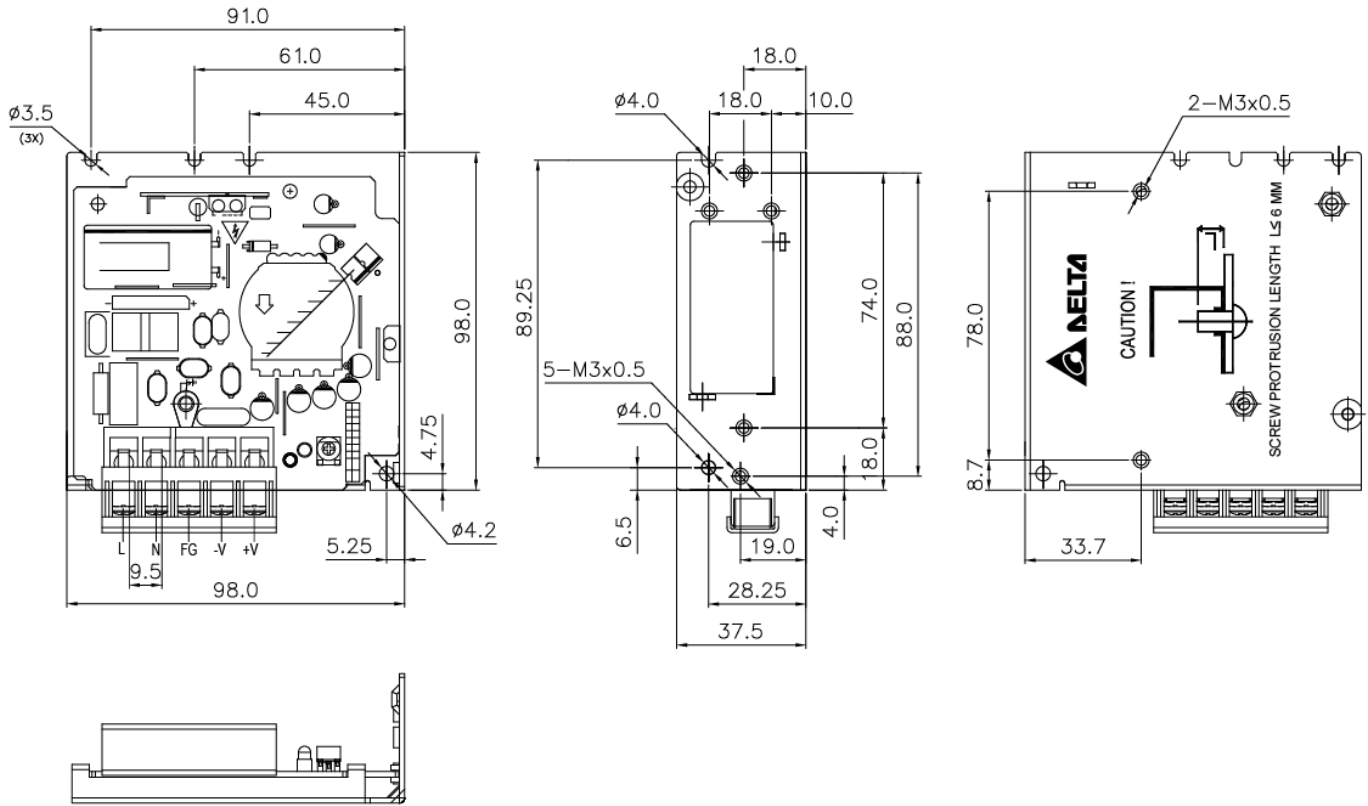

Engineering Data

De-rating

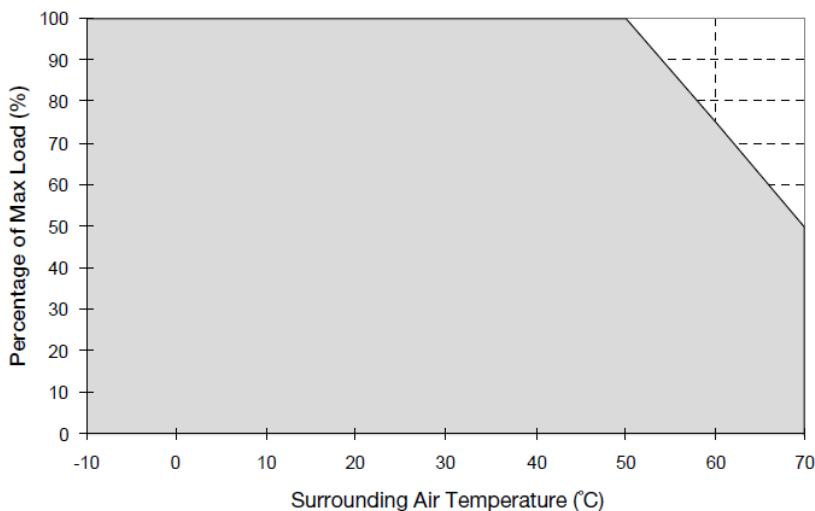

Fig. 1 De-rating for Vertical and Horizontal Mounting Orientation
 > 50°C de-rate power by 2.5% / °C

Note

1. Power supply components may degrade, or be damaged, when the power supply is continuously used outside the shaded region, refer to the graph shown in Fig. 1.
2. If the output capacity is not reduced when the surrounding air temperature >50°C, the device will run into Over Temperature Protection. When activated, the output voltage will go into bouncing mode and will recover when the surrounding air temperature is lowered or the load is reduced as far as necessary to keep the device in working condition.
3. In order for the device to function in the manner intended, it is also necessary to keep a safety distance of 20mm with adjacent units while the device is in operation.
4. Depending on the surrounding air temperature and output load delivered by the power supply, the device can be very hot!
5. If the device has to be mounted in any other orientation, please do not hesitate to contact info@deltapsu.com for more details.

PMT Panel Mount Power Supply

5V 50W 1 Phase / PMT-5V50W1A□

Output De-rating VS. Input Voltage

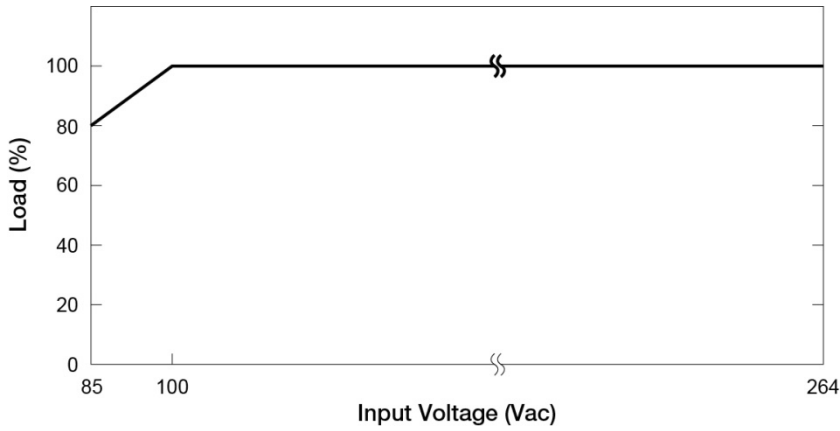

■ No output power de-rating for the input voltage from 100Vac to 264Vac

Assembly & Installation

- Ⓐ Mounting holes for power supply (device). The power supply shall be mounted on minimum 2 mounting holes using M3 screw minimum 5mm length.
- Ⓑ This surface belongs to customer's end system or panel where the power supply is mounted.
- Ⓒ Connector

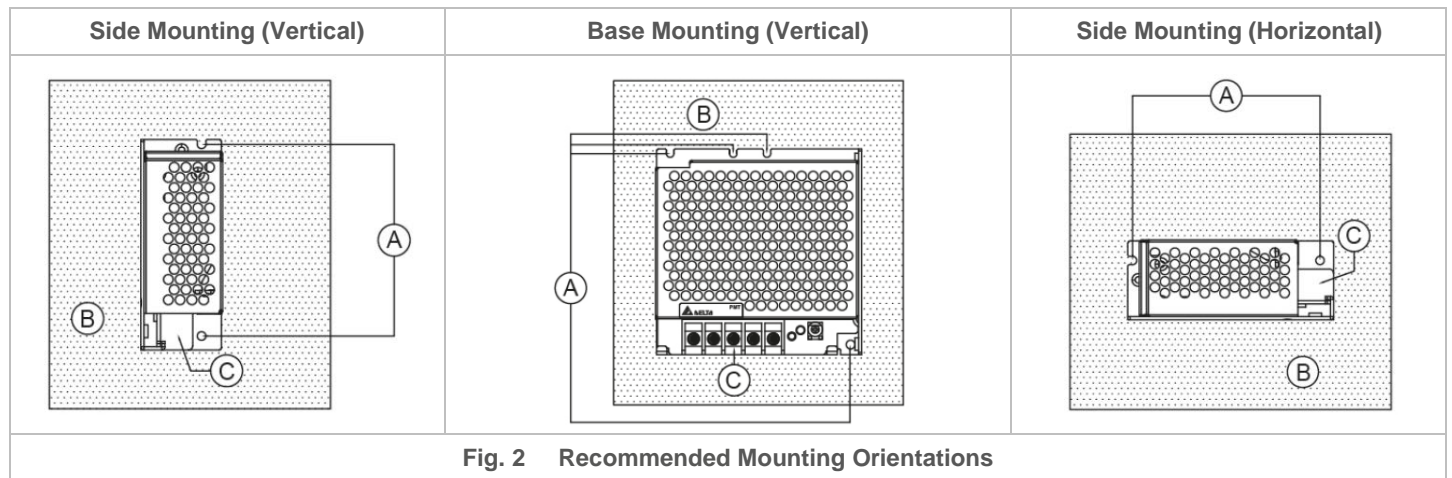

- **PM□-5V50W1A□ / PM□-5V50W1AG:** Use flexible cable (stranded or solid) of AWG No. 14-12. User should calculate and select the suitable wire specification (type/quantity/diameter) according to actual output current. The torque at the Connector shall not exceed 13Kgf.cm. The insulation stripping length should not exceed 0.275" or 7mm (Refer to Fig. 3).

PMT Panel Mount Power Supply

5V 50W 1 Phase / PMT-5V50W1A□

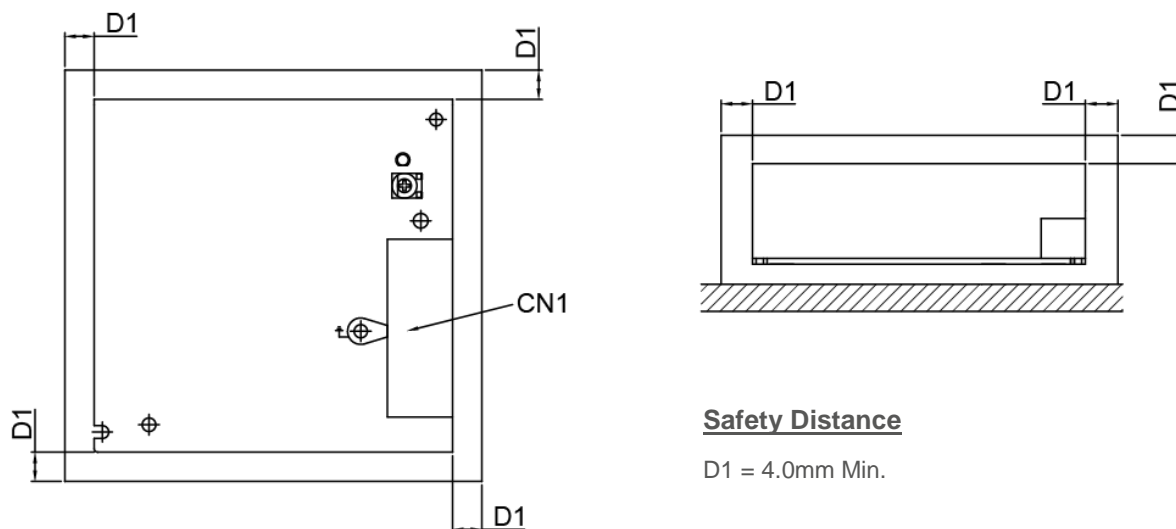

Fig. 3 Assembly Reference

Ensure the mounted device is kept at $\geq 4\text{mm}$ safety distance at all sides from other components and equipments. In addition, to ensure sufficient convection cooling, always maintain a distance of $\geq 20\text{mm}$ from ventilated surfaces while the device is in operation.

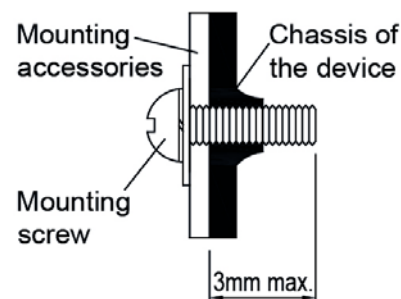

Fig. 4 Mounting Screw

- For PMT and PML Series (Refer to Fig. 4): Only use M3 screw $\leq 3\text{mm}$ through the base mounting holes. This is to keep a safe distance between the screw and internal components. Recommended mounting tightening torque: 4~7Kgf.cm.

Safety Instructions

- If user's mounting orientation is not according to the recommended mounting orientations, please consult Delta for further information.
- L frame (PML) and Open frame (PMB) options are to be manufactured by Delta and not to be reconfigured by users from the standard enclosed configuration.
- The device is not recommended to be placed on low thermal conductive surface. For example, plastics.
- The enclosure of the device can become very hot depending on the ambient temperature and load of the power supply. Do not touch the device while it is in operation or immediately after power is turned OFF. Risk of burning!
- Do not touch the terminals while power is being supplied. Risk of electric shock.
- Prevent any foreign metal, particles or conductors from entering the device through the openings during installation. It may cause electric shock, safety hazard, fire and/or product failure.
- The power supply must be mounted by metal screws onto a grounded metal surface. It is highly recommended that the Earth terminal on the connector be connected to the grounded surface.
- Warning (For Standard Terminal Block and Front Face Terminal Block products): When connecting the device, secure Earth connection before connecting L and N. When disconnecting the device, remove L and N connections before removing the Earth connection.

PMT Panel Mount Power Supply

5V 50W 1 Phase / PMT-5V50W1A□

Accessories

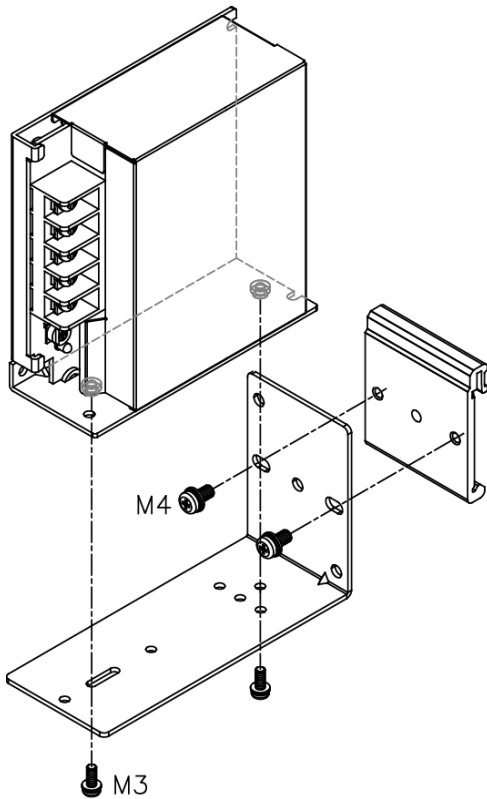

L-01: Latch
P-03: Bracket

These accessories are used to mount the panel mount power supply onto a DIN rail.

Functions

Start-up Time

The time required for the output voltage to reach 90% of its set value, after the input voltage is applied.

Rise Time

The time required for the output voltage to change from 10% to 90% of its set value.

Hold-up Time

Hold up time is the time when the AC input collapses and output voltage retains regulation for a certain period of time. The time required for the output to reach 95% of its set value, after the input voltage is removed.

■ Graph illustrating the Start-up Time, Rise Time, and Hold-up Time

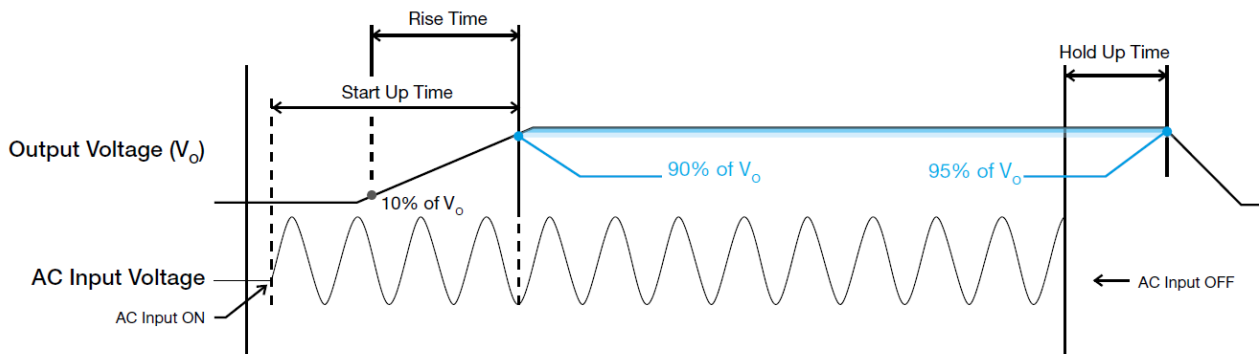

PMT Panel Mount Power Supply

5V 50W 1 Phase / PMT-5V50W1A□

Inrush Current

Inrush current is the peak, instantaneous, input current measured and, occurs when the input voltage is first applied. For AC input voltages, the maximum peak value of inrush current will occur during the first half cycle of the applied AC voltage. This peak value decreases exponentially during subsequent cycles of AC voltage.

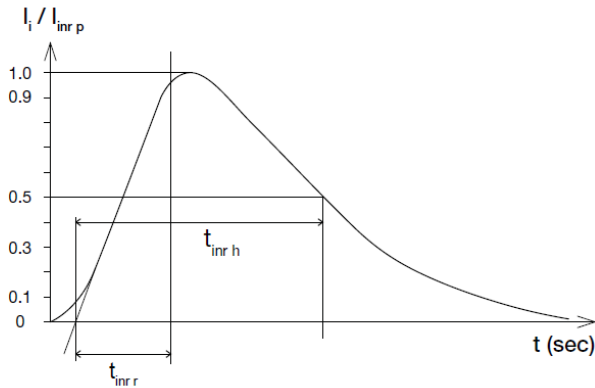

Overload & Overcurrent Protections

The power supply's Overload (OLP) and Overcurrent (OCP) Protections will be activated when output current exceeds 105% of I_O (Max load). In such occurrence, the V_O will start to droop and once the power supply has reached its maximum power limit, the protection is activated and the power supply will go into "Hiccup mode" (Auto-Recovery). The power supply will recover once the fault condition of the OLP and OCP is removed and I_O is back within the specifications.

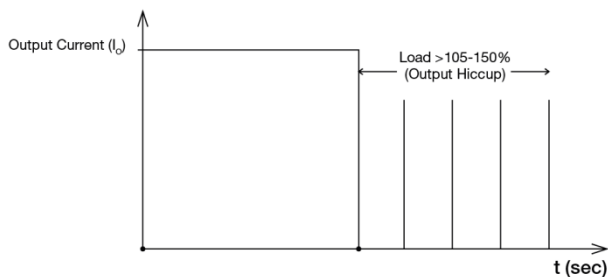

It is not recommended to prolong the duration of I_O when it is <105% but >100%, since it may cause damage to the PSU.

Others



Delta RoHS Compliant

Restriction of the usage of hazardous substances

The European directive 2011/65/EU limits the maximum impurity level of homogeneous materials such as lead, mercury, cadmium, chrome, polybrominated flame retardants PBB and PBDE for the use in electrical and electronic equipment. RoHS is the abbreviation for "Restriction of the use of certain hazardous substances in electrical and electronic equipment".

This product conforms to this standard.

Dynamic Response

The power supply output voltage will remain within $\pm 10\%$ of its steady state value, when subjected to a dynamic load from 0 to 100% of its rated current.

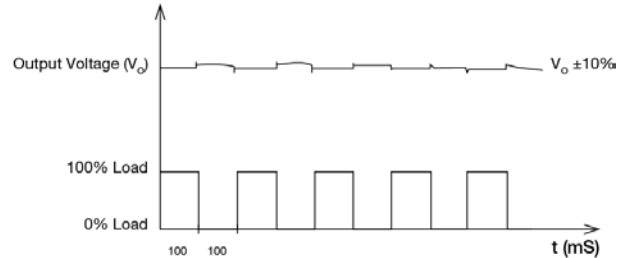

Overvoltage Protection

The power supply's overvoltage circuit will be activated when its internal feedback circuit fails. The output voltage shall not exceed its specifications defined on Page 3 under "Protections".

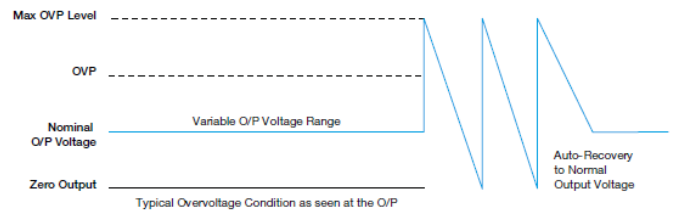

Over Temperature Protection

As mentioned above, the power supply also has Over Temperature Protection (OTP). In the event of a higher operating temperature at 100% load, the power supply will run into OTP when the operating temperature is beyond what is recommended in the de-rating graph. When activated, the output voltage will go into bouncing mode until the temperature drops to its normal operating temperature as recommended in the de-rating graph.

Short Circuit Protection

The power supply's output OLP/OCP function also provides protection against short circuits. When a short circuit is applied, the output current will operate in "Hiccup mode", as shown in the illustration in the OLP/OCP section on this page. The power supply will return to normal operation after the short circuit is removed.